

Data sheet

Video recorder LINAX DR3000



Function and system design

Measuring principle	<p>Electronic acquisition, display, recording, analysis, remote transmission and archiving of analog and digital input signals as well as calculated values.</p> <p>The device is intended for installation in a panel or cabinet door. There is also the option of operating it in a desktop housing or field housing.</p>
Measuring system	<p>Multichannel data recording system with multicolor TFT display (178 mm / 7" screen size), internal memory, external memory (SD card and USB stick), galvanically isolated universal inputs (U, I, TC, RTD, pulse, frequency), HART® inputs, digital inputs, transmitter power supply, limit relays, digital and analog outputs, communication interfaces (USB, Ethernet, RS232/485), optionally available with Modbus, Profibus DP or PROFINET I/O or EtherNet/IP.</p> <p>An Essential Version of the analysis software is included for SQL-supported data analysis at the PC.</p> <p>i The number of inputs available in the basic device can be individually increased using a maximum of 5 plug-in cards. The device supplies power directly to connected two-wire transmitters. The device is configured and operated via the navigator (jog/shuttle dial) or by touchscreen (optional) using the integrated Web server and a PC, or via an external USB keyboard or mouse. Online help supports the user during local operation.</p> <p>i Ex version:</p> <ul style="list-style-type: none"> ▪ The hazardous area version (Ex version) is only available in conjunction with the stainless steel front and touch control. ▪ In this version, the SD card is integrated in the device and cannot be removed. The card can be read out using the analysis software supplied via USB or Ethernet, or by WebDAV.
Application packages / software options	<p>In the standard version, the Advanced Data Manager has a variety of functions, including an end-to-end safety concept to meet the requirements of FDA 21 CFR Part 11. The following application packages are available to help users meet the requirements of their applications and save time:</p> <ul style="list-style-type: none"> ▪ Mathematics ▪ Telealarm ▪ Batch management ▪ Wastewater + RSB (rain spillway basin) ▪ Energy calculation <p>The application packages contain the standard functions and the specific package functions. The individual packages can be largely combined as the user requires. The application packages can also be activated retroactively by entering the activation code.</p> <p>Standard functions</p> <ul style="list-style-type: none"> ▪ Signal analysis: external, 1 min to 12 h, day, week, month, year ▪ Web server ▪ User administration compliant with FDA 21 CFR Part 11 ▪ Event log/audit trail ▪ Process screen ▪ Operation time counter ▪ Text entry/comments ▪ Change language

Data sheet

Video recorder LINAX DR3000

- Time synchronization
- Linearization
- Access protection through release code
- E-mail notification in event of alarms and limit violation
- Encrypted e-mail transmission via SSL (TLS)
- Operation via external USB keyboard and mouse
- External USB or network printer

Mathematics

With the mathematics package, measured values of the inputs or the results of other math channels can be linked mathematically. A formula with up to 200 characters can be created using a formula editor. Once entered, the user can then check the plausibility of the formula.

Functions:

- 12 math channels
- Mathematics functions via formula editor
- Basic arithmetic operations, relational operators, logic operations and functions

Telealarm software

The Telealarm software facilitates user mobility, allowing users to respond to events while they are on the road. E-mails or SMS messages triggered by process alarms or other important process events can be sent to several recipients simultaneously or automatically forwarded to a recipient/destination. Messages can be confirmed, relays controlled remotely and current values queried by cellular phone. The Advanced Data Manager with GSM (GPRS) or Ethernet is ideal both for environmental applications to monitor unstaffed outstations, and for tank monitoring applications.

 The Telealarm software contains the mathematics package.

Functions:

- Advanced SMS/e-mail notification in the event of an alarm
- Instantaneous values queried by cellular phone
- Remote relay switching
- Alarm confirmation by SMS

Batch software

Batch management allows users to reliably record and visualize discontinuous processes. User-definable or externally controlled analysis intervals are possible for up to four batches simultaneously. Batches are assigned batch-specific values and the measured data, the start, end and duration of every batch, along with the current batch status, are displayed on the device and in the PC evaluation software. At the end of the batch, a batch print-out is automatically started directly at the device (USB or network printer) or is printed out at a PC with the analysis software.

 The batch software contains the mathematics package.

Functions:

- Batch report for 4 batches simultaneously
- USB barcode reader
- Automatic batch printout
- Preset counter

Wastewater + RSB (rain spillway basin)

The water/wastewater software supports operations monitoring of the water/wastewater sewage network to obtain information about the quality and efficiency of the plant. The daily, weekly, monthly and yearly maximum and minimum value is determined per

quantity channel. Infiltration water recording and the monitoring of rain spillway basins for reservoir and overflow events are also functions of this software option.

 The water/wastewater software contains the mathematics package and the telealarm software.

Functions:

- Rain spillway basin (reservoir/overflow)
- Highest and lowest values for quantities
- Highest and lowest values from ¼-hourly averages
- Determination of infiltration water

Energy package (water + steam)

The energy package allows users to calculate the mass and energy flow in water and steam applications on the basis of the flow, pressure and temperature (or temperature difference) input variables. Furthermore, energy calculations are also possible using glycol-based refrigerant media.

By balancing the results against one another or by linking the results to other input variables (e.g. gas flow, electr. energy), users can calculate overall balances, efficiency levels etc. These values are important indicators for the quality of the process and form the basis for process optimization and maintenance.

The internationally recognized standard IAPWS-IF 97 is used to calculate the thermodynamic state variables of water and steam.

In the energy software, it is also possible to compensate differential pressure flow measurement ("DP-Flow"). The calculation of flow based on the differential pressure method is a special form of flow measurement. Volumes or mass flow rates that are determined using the DP method require specific correction. By solving the calculation equations listed in the standard in an iterative manner, highly accurate results for DP flow measurements can be achieved. The measurement (orifice plate, nozzle, Venturi pipe) is performed in accordance with ISO5167. Flow measurement based on the dynamic pressure method uses the interrelation between differential pressure and flow.

 The energy package contains the mathematics package.

Additional functions:

- 12 math channels
(Channels 1-8: energy-specific formulas and formula editor, channels 9-12: formula editor)
- Heat quantity + mass calculation for water and steam applications
- Efficiency calculation

Dependability

Reliability

Depending on the device version, the mean time between failures (MTBF) is between 52 years and 16 years (calculated based on SN29500 standard at 40°C)

Maintainability

Battery-backed time and data memory. It is advisable to have the backup battery replaced by a service technician after 10 years.

Real time clock (RTC)

- Automatic or manual summer time changeover
- Battery buffer. It is advisable to have the backup battery replaced by a service technician after 10 years.
- Drift: <10 min/year.
- Time synchronization possible via SNTP or via digital input.

Data sheet

Video recorder LINAX DR3000

Standard diagnostic functions as per Namur NE 107

The diagnostic code is made up of the error category as per Namur NE 107 and the message number.

- Cable open circuit, short-circuit
- Incorrect wiring
- Internal device errors
- Overrange/underrange detection
- Ambient temperature out-of-range detection

Device error/alarm relay

One relay can be used as an alarm relay. The selected relay switches if the device detects a system error (e.g. hardware defect) or a malfunction (e.g. cable open circuit).

This "alarm relay" switches if the device status is "F" (Failure). If the device status is "M" (Maintenance required), the alarm relay does not switch.

Safety

Recorded data are saved in a tamper-proof format and can be exported and archived with manipulation protection using the analysis software.

Input

Measured variables

Analog universal inputs

Standard version without universal inputs. Optional multifunction cards (slot 1-5) with 4 universal inputs (4/8/12/16/20) each.

You are free to choose between the following measured variables for each universal input: U, I, RTD, TC, pulse input or frequency input.

Integration of input variable for totalization e.g. flow (m³/h) in quantity (m³).

HART® inputs

Standard version without HART® inputs. Optional HART® input cards (slot 1-5) with 4 inputs (4/8/12/16/20) each.

Both the digital HART® values and the 4 to 20 mA signal can be evaluated at every input.

The 4 HART® values (PV, SV, TV, QV) of a sensor can be evaluated and the analog HART® value (PV) can be measured via the digital HART® signal. Up to 40 digital HART® values can be recorded in total. It is possible to access the HART® sensor in the field from a PC tool. In this way, the sensor can be configured from the control room and the status information of the sensor can be analyzed/displayed. The Advanced Data Manager acts as a HART® Gateway.



Access to the connected sensors is only possible if the device is connected by Ethernet. Port 5094 must be open in the firewall.

Digital inputs

Standard version: 6 digital inputs

Optional digital card (slot 5): 8 additional digital inputs, 6 additional relays and 2 analog outputs

Data sheet

Video recorder LINAX DR3000

Math channels

12 math channels (optional). Mathematics functions can be freely edited via a formula editor.

Integration of calculated values e.g. for totalization.

Limit values

60 limit values (individual channel assignment)

Calculated values

The values of the universal and HART® inputs can be used to perform calculations in the math channels.

The results of the math channels can also be used for calculations in other math channels.

Measuring range According to IEC 60873-1: An additional display error of ± 1 digit is permitted for every measured value.

User-definable measuring ranges per universal input of the multifunction card:

Measured variable	Measuring range	Maximum measured error of measuring range (oMR), temperature drift	Input resistance
Current (I)	0 to 20 mA; 0 to 20 mA quadratic 0 to 5 mA 4 to 20 mA; 4 to 20 mA quadratic ± 20 mA Overrange: up to 22 mA or -22 mA	$\pm 0.1\%$ oMR Temperature drift: $\pm 0.01\%/K$ oMR	Load: 50 Ω $\pm 1 \Omega$
Voltage (U) >1 V	0 to 10 V; 0 to 10 V quadratic 0 to 5 V 1 to 5 V; 1 to 5 V quadratic ± 10 V ± 30 V	$\pm 0.1\%$ oMR Temperature drift: $\pm 0.01\%/K$ oMR	$\geq 1 \text{ M}\Omega$
Voltage (U) ≤ 1 V	0 to 1 V; 0 to 1 V quadratic ± 1 V ± 150 mV	$\pm 0.1\%$ oMR Temperature drift: $\pm 0.01\%/K$ oMR	$\geq 2.5 \text{ M}\Omega$
Resistance thermometer (RTD)	Pt100: -200 to 850 °C (-328 to 1562 °F) (IEC 60751:2008, $\alpha=0.00385$) Pt100: -200 to 510 °C (-328 to 950 °F) (JIS C 1604:1984, $\alpha=0.003916$) Pt100: -200 to 850 °C (-328 to 1562 °F) (GOST 6651-94, $\alpha=0.00391$) Pt500: -200 to 850 °C (-328 to 1562 °F) (IEC 60751:2008, $\alpha=0.00385$) Pt500: -200 to 510 °C (-328 to 950 °F) (JIS C 1604:1984, $\alpha=0.003916$) Pt1000: -200 to 600 °C (-328 to 1112 °F) (IEC 60751:2008, $\alpha=0.00385$) Pt1000: -200 to 510 °C (-328 to 950 °F) (JIS C 1604:1984, $\alpha=0.003916$)	4-wire: $\pm 0.1\%$ oMR 3-wire: $\pm (0.1\% \text{ oMR} + 0.8 \text{ K})$ 2-wire: $\pm (0.1\% \text{ oMR} + 1.5 \text{ K})$ Temperature drift: $\pm 0.01\%/K$ oMR	
	Cu50: -50 to 200 °C (-58 to 392 °F) (GOST 6651-94, $\alpha=4260$) Cu50: -200 to 200 °C (-328 to 392 °F) (GOST 6651-94, $\alpha=4280$) Pt50: -200 to 1100 °C (-328 to 2012 °F) (GOST 6651-94, $\alpha=0.00391$) Cu100: -200 to 200 °C (-328 to 392 °F) (GOST 6651-94, $\alpha=4280$)	4-wire: $\pm 0.2\%$ oMR 3-wire: $\pm (0.2\% \text{ oMR} + 0.8 \text{ K})$ 2-wire: $\pm (0.2\% \text{ oMR} + 1.5 \text{ K})$ Temperature drift: $\pm 0.02\%/K$ oMR	
	Pt46: -200 to 1100 °C (-328 to 2012 °F) (GOST 6651-94, $\alpha=0.00391$) Cu53: -200 to 200 °C (-328 to 392 °F) (GOST 6651-94, $\alpha=4280$)	4-wire: $\pm 0.3\%$ oMR 3-wire: $\pm (0.3\% \text{ oMR} + 0.8 \text{ K})$ 2-wire: $\pm (0.3\% \text{ oMR} + 1.5 \text{ K})$ Temperature drift: $\pm 0.02\%/K$ oMR	
Thermocouples (TC)	Type J (Fe-CuNi): -210 to 1200 °C (-346 to 2192 °F) (IEC 60584:2013) Type K (NiCr-Ni): -270 to 1300 °C (-454 to 2372 °F) (IEC 60584:2013) Type L (NiCr-CuNi): -200 to 800 °C (-328 to 1472 °F) (GOST R8.585:2001) Type L (Fe-CuNi): -200 to 900 °C (-328 to 1652 °F) (DIN 43710-1985) Type N (NiCrSi-NiSi): -270 to 1300 °C (-454 to 2372 °F) (IEC 60584:2013) Type T (Cu-CuNi): -270 to 400 °C (-454 to 752 °F) (IEC 60584:2013)	$\pm 0.1\%$ oMR from -100 °C (-148 °F) $\pm 0.1\%$ oMR from -130 °C (-202 °F) $\pm 0.1\%$ oMR from -100 °C (-148 °F) $\pm 0.1\%$ oMR from -100 °C (-148 °F) $\pm 0.1\%$ oMR from -100 °C (-148 °F) $\pm 0.1\%$ oMR from -100 °C (-148 °F) Temperature drift: $\pm 0.01\%/K$ oMR	$\geq 1 \text{ M}\Omega$

Data sheet

Video recorder LINAX DR3000

Measured variable	Measuring range	Maximum measured error of measuring range (oMR), temperature drift	Input resistance
	Type A (W5Re-W20Re): 0 to 2500 °C (32 to 4532 °F) (ASTME 988-96) Type B (Pt30Rh-Pt6Rh): 42 to 1820 °C (107.6 to 3308 °F) (IEC 60584:2013) Type C (W5Re-W26Re): 0 to 2315 °C (32 to 4199 °F) (ASTME 988-96) Type D (W3Re-W25Re): 0 to 2315 °C (32 to 4199 °F) (ASTME 988-96) Type R (Pt13Rh-Pt): -50 to 1768 °C (-58 to 3214 °F) (IEC 60584:2013) Type S (Pt10Rh-Pt): -50 to 1768 °C (-58 to 3214 °F) (IEC 60584:2013)	±0.15% oMR from 500 °C (932 °F) ±0.15% oMR from 600 °C (1112 °F) ±0.15% oMR from 500 °C (932 °F) ±0.15% oMR from 500 °C (932 °F) ±0.15% oMR from 100 °C (212 °F) ±0.15% oMR from 100 °C (212 °F) Temperature drift: ±0.01%/K oMR	≥1 MΩ
Pulse input (I) ¹⁾	Min. Pulse length 40 µs, max. 12.5 kHz; 0 to 7 mA = LOW; 13 to 20 mA = HIGH		Load: 50 Ω ±1 Ω
Frequency input (I) ¹⁾	0 to 10 kHz, overrange: up to 12.5 kHz; 0 to 7 mA = LOW; 13 to 20 mA = HIGH	±0.02% @ f <100 Hz of reading ±0.01% @ f ≥100 Hz of reading Temperature drift: 0.01% of measured value over the entire temperature range	

1) If a universal input is used as a frequency or pulse input, a series resistor must be used in series connection with the voltage source. Example: 1.2 kΩ series resistor at 24 V

Current measuring range of the HART® card:

Measured variable	Measuring range	Maximum measured error of measuring range (oMR), temperature drift	Input impedance
Current (I)	4 to 20 mA Overrange: up to 22 mA	±0.1% oMR Temperature drift: ±0.01%/K oMR	Load: 10 Ω ±1 Ω

Maximum load and additional input parameters of the multifunction cards

Limit values for input voltage and current as well as cable open circuit detection/line influence/temperature compensation:

Measured variable	Limit values (steady-state, without destroying input)	Cable open circuit detection/line influence/temperature compensation
Current (I)	Maximum permitted input voltage: 2.5 V Maximum permitted input current: 50 mA	4 to 20 mA range with disengageable cable open circuit monitoring to NAMUR NE43. The following error ranges apply when NAMUR NE43 monitoring is switched on: ≤3.8 mA: underrange ≥20.5 mA: overrange ≤ 3.6 mA or ≥ 21.0 mA: open circuit (display shows: - - - -)
Pulse, frequency (I)	Maximum permitted input voltage: 2.5 V Maximum permitted input current: 50 mA	No cable open circuit monitoring
Voltage (U) >1 V	Maximum permitted input voltage: 35 V	1 to 5 V range with disengageable cable open circuit monitoring: <0.8 V or >5.2 V: cable open circuit (display shows: - - - -)
Voltage (U) ≤1 V	Maximum permitted input voltage: 24 V	
Resistance thermometer (RTD)	Measuring current: ≤1 mA	Maximum barrier resistance (or line resistance): 4-wire: max. 200 Ω; 3-wire: max. 40 Ω Maximum influence of barrier resistance (or line resistance) for Pt100, Pt500 and Pt1000: 4-wire: 2 ppm/Ω, 3-wire: 20 ppm/Ω Maximum influence of barrier resistance (or line resistance) for Pt46, Pt50, Cu50, Cu53, Cu100 and Cu500: 4-wire: 6 ppm/Ω, 3-wire: 60 ppm/Ω Cable open circuit monitoring if any connection is interrupted.
Thermocouples (TC)	Maximum permitted input voltage: 24 V	Influence of line resistance: <0.001%/Ω Error, internal temperature compensation: ≤ 2 K

Data sheet

Video recorder LINAX DR3000

Maximum load and additional input parameters of the HART® cards

Limit values for input voltage and current as well as cable open circuit detection:

Measured variable	Limit values (steady-state, without destroying input)	Cable open circuit detection
Current (I)	Maximum permitted input voltage: 0.5 V Maximum permitted input current: 50 mA	4 to 20 mA range with disengageable cable open circuit monitoring to NAMUR NE43. The following error ranges apply when NAMUR NE43 monitoring is switched on: ≤3.8 mA: underrange ≥20.5 mA: overrange ≤ 3.6 mA or ≥ 21.0 mA: open circuit (display shows: ---)

Scan rate

Current/voltage/pulse/frequency input: 100 ms per channel

Thermocouples and resistance temperature detector: 1 s per channel

Data storage / memory cycle

Choose from the following for the memory cycle: off / 100 ms / 1s / 2s / 3s / 4s / 5s / 10s / 15s / 20s / 30s / 1min / 2min / 3min / 4min / 5min / 10min / 15min / 30min / 1h



Highspeed storage (100 ms) can be selected for up to 8 channels in Group 1 only.

Highspeed storage is not available in the energy package (option).

Typical recording length

Prerequisites for following tables:

- No limit value violation / integration
- Digital input not used
- Signal analysis 1: off, 2: day, 3: month, 4: year
- No active math channels



Frequent entries in the event log reduce the memory availability!

256 MB internal memory:

Analog inputs	Channels in groups	Storage cycle (weeks, days, hours)				
		5 min	1 min	30 s	10 s	1 s
1	1/0/0/0/0/0/0/0/0/0	1796, 6, 13	362, 5, 17	181, 4, 9	60, 4, 3	6, 0, 10
4	4/0/0/0/0/0/0/0/0/0	1319, 2, 23	267, 5, 17	134, 1, 2	44, 5, 10	4, 3, 8
8	4/4/0/0/0/0/0/0/0/0	661, 4, 3	133, 6, 21	67, 0, 16	22, 2, 17	2, 1, 16
12	4/4/4/0/0/0/0/0/0/0	441, 3, 8	89, 2, 9	44, 5, 3	14, 6, 11	1, 3, 10
20	4/4/4/4/4/0/0/0/0/0	265, 0, 15	53, 4, 7	26, 5, 21	8, 6, 16	0, 6, 6
40	4/4/4/4/4/4/4/4/4/4	132, 4, 8	26, 5, 16	13, 2, 23	4, 3, 8	0, 3, 3

External memory, 1 GB SD card:

Analog inputs	Channels in groups	Storage cycle (weeks, days, hours)				
		5 min	1 min	30 s	10 s	1 s
1	1/0/0/0/0/0/0/0/0/0	12825, 5, 20	2580, 4, 18	1291, 2, 5	430, 4, 14	43, 0, 12
4	4/0/0/0/0/0/0/0/0/0	8672, 5, 12	1749, 6, 13	875, 6, 13	292, 1, 8	29, 1, 14
8	4/4/0/0/0/0/0/0/0/0	4343, 1, 1	875, 1, 17	438, 0, 6	146, 0, 17	14, 4, 7
12	4/4/4/0/0/0/0/0/0/0	2896, 6, 13	583, 3, 21	292, 0, 6	97, 2, 20	9, 5, 4

Data sheet

Video recorder LINAX DR3000

Analog inputs	Channels in groups	Storage cycle (weeks, days, hours)				
		5 min	1 min	30 s	10 s	1 s
20	4/4/4/4/4/0/0/0/0/0	1738, 6, 4	350, 1, 3	175, 1, 14	58, 3, 2	5, 5, 22
40	4/4/4/4/4/4/4/4/4/4	869, 5, 0	175, 0, 15	87, 4, 7	29, 1, 13	2, 6, 11

 The available storage capacity of the internal and external memory can be displayed in the main menu under **"Diagnostics → Device information → Memory information"**. The storage capacity depends on the specific device set-up.

Converter resolution

24 bit

Totalization

The interim value, daily value, weekly value, monthly value, annual value and overall value can be determined (13-digit, 64 bit).

Analysis

Recording of quantity/operating time (standard function), also a min/max/median analysis within the set time frame.

Digital inputs	Input level	Logical "0" (corresponds to -3 to +5 V), activation with logical "1" (corresponds to +12 to +30 V)
	Input frequency	max. 25 Hz
	Pulse length	Min. 20 ms (pulse counter)
	Pulse length	Min. 100 ms (control input, messages, operating time)
	Input current	max. 2 mA
	Input voltage	Max. 30 V

Selectable functions

- Functions of the digital input: control input, ON/OFF message, pulse counter (13-digit, 64-bit), operating time, message+operating time, quantity from time, Profibus DP, EtherNet/IP, PROFINET.
- Functions of the control input: start recording, screensaver on, lock setup, time synchronization, change group, limit value monitoring on/off, individual LV on/off, block keyboard/navigator, start/stop analysis.
Additionally for the batch software option: reset batch number, batch limit values on/off.

Output

Auxiliary voltage output The auxiliary voltage output can be used for loop power supply or to control the digital inputs. The auxiliary voltage is short-circuit proof and galvanically isolated.

Output voltage	24 V _{DC} ±15%
Output current	Max. 250 mA

Analog and pulse outputs

Number

Optional digital card (slot 5): 2 analog outputs which can be operated as current or pulse outputs.

Analog output (current output)

Output current: 0/4 to 20 mA with 10% overrange

Max. output voltage: approx. 16 V

Accuracy: $\leq 0.1\%$ of end of range value

Temperature drift: $\leq 0.015\%/K$ of end of range value

Resolution: 13 Bit

Load: 0 to 500 Ω

Error signal as per NAMUR NE43: 3.6 mA or 21 mA can be configured

Digital output (pulse output)

Output voltage:

≤ 5 V corresponds to LOW

≥ 12 V corresponds to HIGH

Short-circuit proof (maximum 25 mA)

Speed: max. 1000 pulses/s

Pulse width: 0.5 to 1000 ms



The pulse pause is at least as long as the pulse width.

Load: ≥ 1 k Ω

Relay outputs

A mix of low voltage (230 V) and safety extra low voltage (SELV circuits) is not permitted at the connections of the relay contacts.

Alarm relay

1 alarm relay with changeover contact.

Standard relay

5 relays with NO contact, e.g. for limit value messages (can be configured as NC contact).

Optional relays

Optional digital card (slot 5): 6 additional relays with NO contact e.g. for limit value alarms (can be configured as an NC contact).

Relay switching capacity

- Max. relay switching capacity: 3 A @ 30 V DC
- Max. relay switching capacity: 3 A @ 250 V AC
- Min. switching load: 300 mW

Switching cycles

$> 10^5$

Data sheet

Video recorder LINAX DR3000

Galvanic isolation

All inputs and outputs are galvanically isolated from each other and designed for the following test voltages:

	Relay	Digital in	Analog in/HART®	Analog out	Ethernet	RS232/RS485	USB	Auxiliary voltage output
Relay	500 V _{DC}	2 kV _{DC}	2 kV _{DC}	2 kV _{DC}	2 kV _{DC}	2 kV _{DC}	2 kV _{DC}	2 kV _{DC}
Digital in	2 kV _{DC}	500 V _{DC} but: 1)	500 V _{DC}	500 V _{DC}	500 V _{DC}	500 V _{DC}	500 V _{DC}	500 V _{DC}
Analog in/HART®	2 kV _{DC}	500 V _{DC}	500 V _{DC}	500 V _{DC}	500 V _{DC}	500 V _{DC}	500 V _{DC}	500 V _{DC}
Analog out	2 kV _{DC}	500 V _{DC}	500 V _{DC}	500 V _{DC}	500 V _{DC}	500 V _{DC}	500 V _{DC}	500 V _{DC}
Ethernet	2 kV _{DC}	500 V _{DC}	500 V _{DC}	500 V _{DC}	-	500 V _{DC}	500 V _{DC}	500 V _{DC}
RS232/RS485	2 kV _{DC}	500 V _{DC}	500 V _{DC}	500 V _{DC}	500 V _{DC}	-	500 V _{DC}	500 V _{DC}
USB	2 kV _{DC}	500 V _{DC}	500 V _{DC}	500 V _{DC}	500 V _{DC}	500 V _{DC}	Galvanically connected	500 V _{DC}
Auxiliary voltage output	2 kV _{DC}	500 V _{DC}	500 V _{DC}	500 V _{DC}	500 V _{DC}	500 V _{DC}	500 V _{DC}	-

1) Test voltage applies between inputs on power unit (terminals D11 to D61) to inputs on optional digital card (terminals D71 to DE1). The inputs are galvanically connected on the same plug-in connector.

Cable specification

Cable specification, spring terminals

All connections on the rear of the device are designed as pluggable screw or spring terminal blocks with reverse polarity protection. This makes the connection very quick and easy. The spring terminals are unlocked with a slotted screwdriver (size 0).

Please note the following when connecting:

- Wire cross-section, auxiliary voltage output, digital I/O and analog I/O: max. 1.5 mm² (14 AWG) (spring terminals)
- Wire cross-section, mains: max. 2.5 mm² (13 AWG) (screw terminals)
- Wire cross-section, relays: max. 2.5 mm² (13 AWG) (spring terminals)
- Stripping length: 10 mm (0.39 in)

 No ferrules must be used when connecting flexible wires to spring terminals.

Shielding and grounding

Optimum electromagnetic compatibility (EMC) can only be guaranteed if the system components and, in particular, the lines - both sensor lines and communication lines - are shielded and the shield forms as complete a cover as possible. A shielded line must be used for sensor lines that are longer than 30 m. A shield coverage of 90% is ideal. In addition, make sure not to cross sensor lines and communication lines when routing them. Connect the shield as often as possible to the reference ground to ensure optimum EMC protection for the different communication protocols and the connected sensors.

To comply with requirements, three different types of shielding are possible:

- Shielding at both ends
- Shielding at one end on the supply side with capacitance termination at the device
- Shielding at one end on the supply side

Experience shows that the best results with regard to EMC are achieved in most cases in installations with one-sided shielding on the supply side (without capacitance termination

Data sheet

Video recorder LINAX DR3000

at the device). Appropriate internal device wiring measures must be taken to allow unrestricted operation when EMC interference is present. These measures have been taken into account for this device. Operation in the event of disturbance variables as per NAMUR NE21 is thus guaranteed.

Where applicable, national installation regulations and guidelines must be observed during the installation! Where there are large differences in potential between the individual grounding points, only one point of the shielding is connected directly with the reference ground.

i If the shielding of the cable is grounded at more than one point in systems without potential matching, mains frequency equalizing currents can occur. These can damage the signal cable or significantly impact signal transmission. In such cases the shielding of the signal cable is to be grounded on one side only, i.e. it may not be connected to the ground terminal of the housing. The shield that is not connected should be insulated!

Power supply

Terminals on back of device

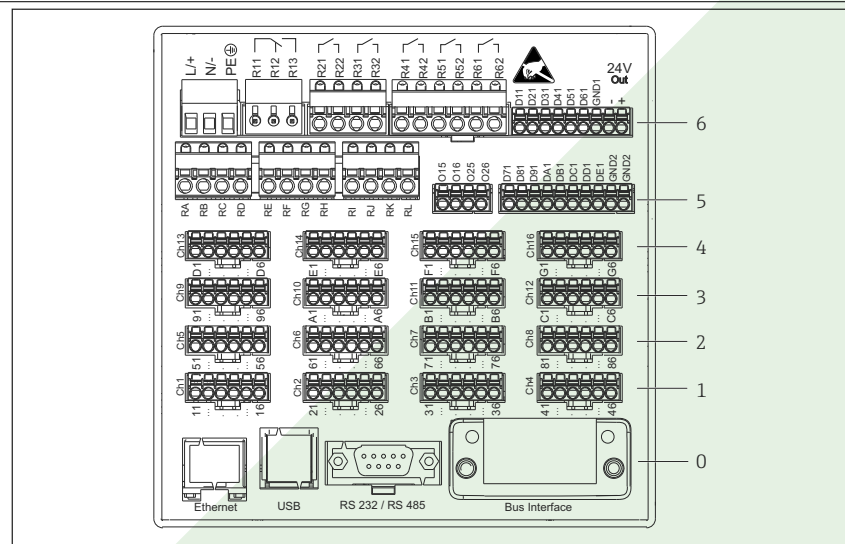

16 Terminals on back of device

- 6 Slot 6: Power supply with relays
- 5 Slot 5: Multifunction card or HART® card (channels 17-20) or digital card
- 4 Slot 4: Multifunction card or HART® card (channels 13-16)
- 3 Slot 3: Multifunction card or HART® card (channels 9-12)
- 2 Slot 2: Multifunction card or HART® card (channels 5-8)
- 1 Slot 1: Multifunction card or HART® card (channels 1-4)
- 0 Slot 0: CPU card with interfaces

Supply voltage

- Extra-low voltage power supply unit ± 24 V AC/DC (-10% / +15%) 50/60Hz
- Low voltage power supply unit 100 to 230 V AC ($\pm 10\%$) 50/60Hz

i Overcurrent protection (rated current ≤ 10 A) must be installed for the power cable.

Power consumption

- 100 to 230 V: max. 40 VA
- 24 V: max. 30 VA

Data sheet

Video recorder LINAX DR3000

The power actually consumed depends on the individual operating state and the device version (LPS, USB, brightness of screen, number of channels, etc). The active power here is approx. 3 W to 25 W.

Power supply failure	Battery-backed time and data memory. The device starts automatically following a power failure.
----------------------	---

Electrical connection	Details about the electrical connection: →  16
-----------------------	---

Electrical connection, terminal assignment	Circuit diagram
---	------------------------

Data sheet

Video recorder LINAX DR3000

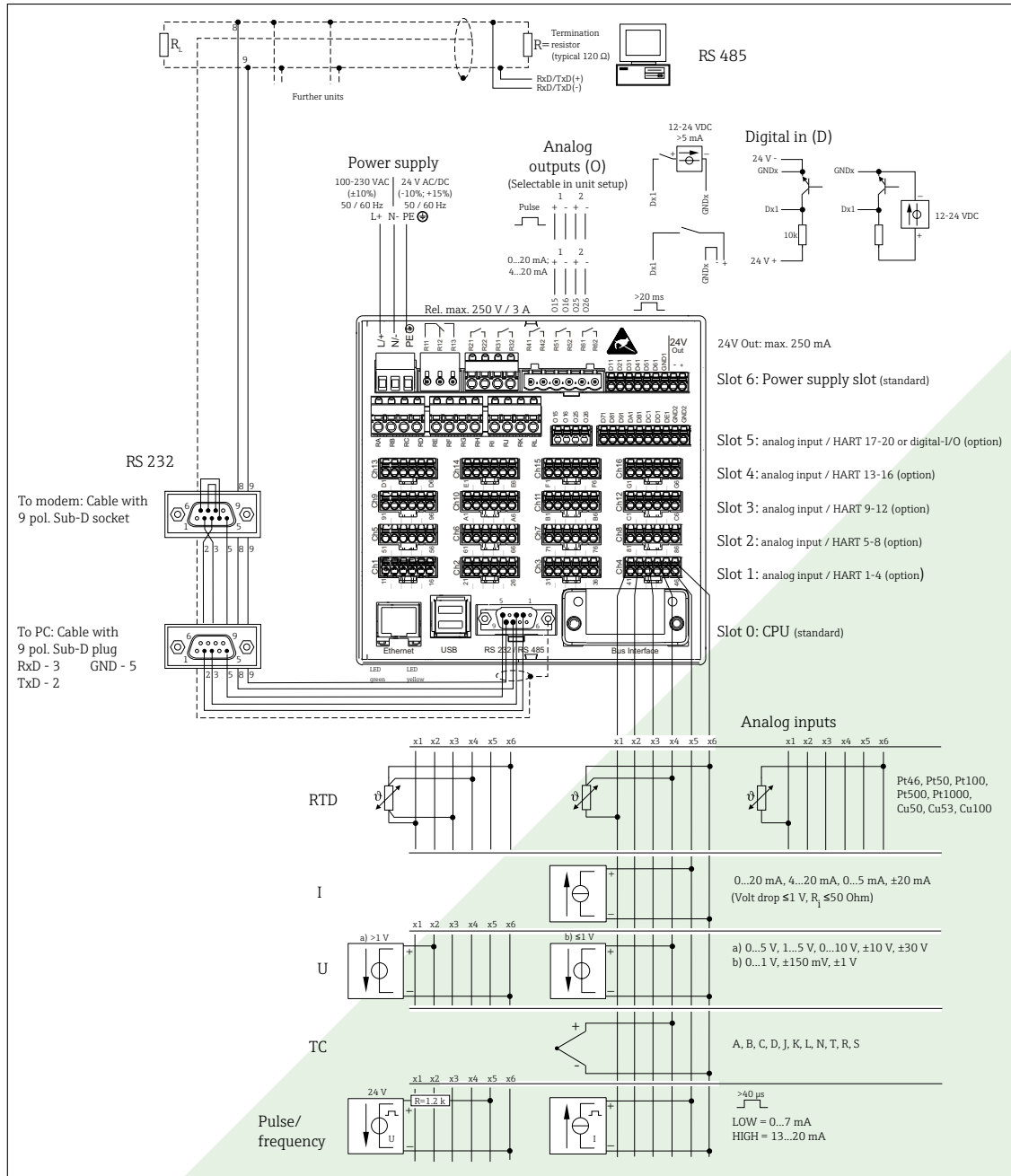

17 For connection examples of the HART® inputs (optional), see the Operating Instructions → 23

Data sheet

Video recorder LINAX DR3000

Supply voltage (power unit, slot 6)

Power unit type	Terminal		
100-230 VAC	L+	N-	PE
	Phase L	Zero conductor N	Ground
24 V AC/DC	L+	N-	PE
	Phase L or +	Zero conductor N or -	Ground

Relay (power unit, slot 6)

Type	Terminal (max. 250 V, 3 A)				
Alarm relay 1	R11	R12	R13		
	Changeover contact	Normally closed contact (NC) ¹⁾	Normally open contact (NO) ²⁾		
Relay 2 to 6				Rx1	Rx2
				Switching contact	Normally open contact (NO ²⁾)

- 1) NC = normally closed (breaker)
 2) NO = normally open (maker)

i The open or close function (= activation or deactivation of the relay coil) in a limit event can be configured in the setup: "Setup -> Advanced setup -> Outputs -> Relay -> Relay x". However, in the event of a power failure, the relay adopts its quiescent switch state regardless of the setting programmed.

Digital inputs; auxiliary voltage output (power unit, slot 6)

Type	Terminal		
Digital input 1 to 6	D11 to D61	GND1	
	Digital input 1 to 6 (+)	Ground (-) for digital inputs 1 to 6	

Data sheet

Video recorder LINAX DR3000

Type	Terminal			
Auxiliary voltage output, not stabilized, max. 250 mA			24V Out -	24V Out +
			- Ground	+ 24V (±15%)

i If the auxiliary voltage is to be used for the digital inputs, the **24 V out -** terminal of the auxiliary voltage output must be connected with the **GND1** terminal.

Analog inputs (slot 1-5)

The first digit (x) of the two-digit terminal number corresponds to the associated channel:

Type	Terminal					
	x1	x2	x3	x4	x5	x6
Current/pulse/frequency input ¹⁾					(+)	(-)
Voltage > 1V		(+)				(-)
Voltage ≤ 1V				(+)		(-)
Resistance thermometer RTD (2-wire)	(A)					(B)
Resistance thermometer RTD (3-wire)	(A)			b (sense)		(B)
Resistance thermometer RTD (4-wire)	(A)		a (sense)	b (sense)		(B)
Thermocouples TC				(+)		(-)

1) If a universal input is used as a frequency or pulse input, a series resistor must be used in series connection with the voltage source. Example: 1.2 kΩ series resistor at 24 V

Data sheet

Video recorder LINAX DR3000

HART® inputs (slot 1-5)

The first digit (x) of the two-digit terminal number corresponds to the associated channel:

Type	Terminal					
	x1	x2	x3	x4	x5	x6
HART® (4 to 20 mA)	SHD	H_1	H_2	R _{com}	I+	I-

- i** A 250 Ω communication resistor (load) is installed on the device side between terminals x4 and x5.
- A 10 Ω resistor (shunt) is installed on the device side at the current input between terminals x5 and x6.
- Terminals x2 and x3 (H_1 and H_2) are jumpered internally.
- The internal HART® modem is located between terminals x2/x3 and x6.

Relay extension (digital card, slot 5)

Type	Terminal (max. 250 V, 3 A)			
Relay 7, 8	RA	RB	RC	RD
Relay 9, 10	RE	RF	RG	RH
Relay 11, 12	RI	RJ	RK	RL
	Switching contact	Normally open contact ⁽¹⁾	Switching contact	Normally open contact ⁽²⁾

1) NO)

2) NO)

- i** The open or close function (= activation or deactivation of the relay coil) in a limit event can be configured in the setup: "Setup -> Advanced setup -> Outputs -> Relay -> Relay x". However, in the event of a power failure, the relay adopts its quiescent switch state regardless of the setting programmed.

Analog outputs (digital card, slot 5)

Type	Terminal			
Analog output 1-2	O15	O16	O25	O26
	Analog output 1 (+)	Ground, analog output 1 (-)	Analog output 2 (+)	Ground, analog output 2 (-)

Data sheet

Video recorder LINAX DR3000

Extension of digital inputs (digital card, slot 5)

Type	Terminal		
Digital input 7 to 14	D71 to DE1	GND2	GND2
	Digital input 7 to 14 (+)	Ground (-) for digital inputs 7 to 14	Ground (-) for digital inputs 7 to 14

i If the auxiliary voltage is to be used for the digital inputs, the **24 V out** - terminal of the auxiliary voltage output (power unit, slot 6) must be connected with the **GND2** terminal.

Connector

- Panel-mounted device: connected to mains via plug-in screw terminals with reverse polarity protection
- Desktop version (option): connected to mains via IEC connector

Overvoltage protection

To avoid high-energy transients on long signal cables, connect a suitable surge arrester upstream (e.g. E+H HAW562) in series upstream.

Connection data interface, communication

USB interfaces:

1 x USB port type A (host) on the front of device (only for version with navigator and front interfaces)

A USB 2.0 port is available on a shielded USB A socket at the front of the device. A USB stick as a memory medium, for example, can be connected to this port. An external keyboard/mouse for device operation, a USB hub, a barcode reader or a printer (PCL5c or higher) may also be connected.

1 x USB port type B (function) on the front of device (only for version with navigator and front interfaces)

A USB 2.0 port is available on a shielded USB B socket at the front of the device. This can be used to connect the device for communication with a laptop, for example.

2 x USB port type A (host) on the rear of the device (standard)

Two USB 2.0 ports are available on shielded USB A sockets at the rear of the device. A USB stick as a memory medium, for example, can be connected to these ports. An external keyboard/mouse for device operation, a USB hub, a barcode reader or a printer (PCL5c or higher) may also be connected.

- **i** USB-2.0 is compatible with USB-1.1 or USB-3.0, i.e. communication is possible.
- The assignment of the USB interfaces complies with the standard such that shielded standard cables with a maximum length of 3 meters (9.8 ft) can be used here.
- The USB devices are detected by the "plug-and-play" function. If several devices of the same type are connected, only the USB device that was connected first is available.
- A maximum of 8 external USB devices (incl. USB hub) can be connected if they do not exceed the maximum load of 500 mA. If overloaded, the corresponding USB devices are automatically disabled. An active USB hub can be used for higher power ratings.

Data sheet

Video recorder LINAX DR3000

Reference list for USB printers:

HP Color LaserJet CP1515n, HP Color LaserJet Pro CP1525n, ECOSYS P6021cdn.

 The printer must support PCL5c (or higher). GDI printers are not supported!

Reference list for USB barcode readers:

Datalogic Gryphon D230; Metrologic MS5100 Eclipse Series; Symbol LS2208, Datalogic Quickscan 1, Godex GS220, Honeywell Voyager 9590.

Ethernet interface (standard):

Ethernet interface on back, 10/100 Base-T, plug type RJ45. The Ethernet interface can be used to integrate the device via a hub or switch into a PC network (TCP/ IP Ethernet). A standard patch cable (e.g. CAT5E) can be used for the connection. Using DHCP, the device can be fully integrated into an existing network without the need for additional configuration. The device can be accessed from every PC in the network. Normally only the automatic assignment of the IP address must be configured at the client. When the device is started, it can automatically retrieve the IP address, subnet mask and gateway from a DHCP server. If a DHCP is not used (depending on the specific network) these settings must be made directly in the device. Two Ethernet function LEDs are located on the rear of the device.

The following functions are implemented:

- Data communication with PC software (analysis software, OPC server)
- Web server
- WebDAV (Web-based Distributed Authoring and Versioning) is an open standard for the provisioning of files via the HTTP protocol. The data saved on the device's SD card can be read out using a PC. A web browser or dedicated WebDAV client can be selected as network drive on the PC for this purpose.

Requirements with regard to a network printer

Network printer reference list:

HP Color LaserJet CP1515n, HP Color LaserJet Pro CP1525n, ECOSYS P6021cdn

 The printer must support PCL5c (or higher). GDI printers are not supported!

Ethernet Modbus TCP master (option):

As a Modbus master, the device can interrogate other Modbus slaves via Ethernet. The Modbus TCP master can be operated in parallel with the Profibus DP slave, Modbus RTU/TCP slave or PROFINET I/O Device.

Up to 40 analog inputs can be transmitted via Modbus and stored in the device.

Ethernet Modbus TCP slave (option):

Connection to SCADA systems (Modbus master).

Up to 40 analog inputs and 20 (14 real + 6 virtual) digital inputs can be transmitted via Modbus and stored in the device.

Serial RS232/RS485 interface:

A combined RS232/RS485 connection is available on a shielded SUB D9 socket at the rear of the device. This can be used for data transfer and to connect a modem. For communication via modem, we recommend an industrial modem with a watchdog function.

- The following baud rates are supported: 9600, 19200, 38400, 57600, 115200
- Max. cable length with a shielded cable: 2 m (6.6 ft) (RS232), or 1000 m (3281 ft) (RS485)

 Only one interface can be used at any one time (RS232 or RS485).

Modbus RTU master (option):

As a Modbus master, the device can interrogate other Modbus slaves via RS485. The Modbus RTU master can be operated in parallel with the Profibus-DP slave, PROFINET I/O Device or Modbus TCP slave.

Up to 40 analog inputs can be transmitted via Modbus and stored in the device.

Modbus RTU slave (option):

The device can be interrogated as a Modbus slave by another Modbus master via RS485.

Up to 40 analog inputs and 20 (14 real + 6 virtual) digital inputs can be transmitted via Modbus and stored in the device.



A Modbus RTU master and RTU slave cannot be operated in parallel.

Remote interrogation with analog or GSM/GPRS wireless modem:

Analog modem:

An analog modem for industrial use (e.g. Devolo or WESTERMO), which is connected to the RS232 interface with a special modem cable (see Accessories), is recommended. → 77

GSM/GPRS wireless modem:

A GSM/GPRS wireless modem (e.g. Cinterion, INSYS or WESTERMO, incl. antenna and power unit) for industrial use, which is connected to the RS232 interface with a special modem cable (see Accessories), is recommended. → 77

Important: the wireless modem needs a SIM card and data transfer subscription. In addition, it must be possible to deactivate the PIN prompt.

AnyBus® interface (CPU card, slot 0, optional)

PROFIBUS-DP slave:

The device can be integrated into a fieldbus system as per the PROFIBUS-DP standard by means of the PROFIBUS-DP interface. Up to 40 analog inputs and 20 (14 real + 6 virtual) digital inputs can be transmitted via PROFIBUS-DP and stored in the device. Bidirectional communication with cyclic data transfer is possible. Connection via Sub-D socket.

Baud rate: maximum 12 Mbit/s.

EtherNet/IP adapter (slave):

Up to 40 analog inputs and 20 (14 real + 6 virtual) digital inputs can be transmitted via EtherNet/IP and stored in the device. The built-in module corresponds to I/O server category (Level 2). It has an integrated 2-port switch, thereby supporting EtherNet/IP communication in line or ring topologies. Connection via 2 RJ45 standard sockets.

PROFINET I/O device:

Up to 40 analog inputs and 20 (14 real + 6 virtual) digital inputs can be transmitted via PROFINET IO and stored in the device. The 2-port module for PROFINET IO meets compliance class B. The integrated switch enables communication in line or ring topologies without an additional external switch. Connection via 2 RJ45 standard sockets.

Performance characteristics

Response time

Input	Output	Time [ms]
Current, voltage, pulse	Relays, OC, analog output	≤ 550
RTD	Relays, OC, analog output	≤ 1150
TC ¹⁾	Relays, OC, analog output	≤ 1550

Data sheet

Video recorder LINAX DR3000

Input	Output	Time [ms]
Cable open circuit detection, current input	Relays, OC, analog output	≤ 1150
Sensor error RTD, TC	Relays, OC, analog output	≤ 5000
Digital input	Relays, OC, analog output	≤ 350
HART® input	Relays, OC, analog output	Non-deterministic

1) If internal measuring point temperature compensation is used, otherwise values as for voltage

Reference operating conditions	Reference temperature	25 °C (77 °F) ±5 K
	Warm-up period	120 min.
	Humidity	20 to 60 % rel. humidity

Hysteresis Can be configured for limit values in the setup

Long-term drift As per IEC 61298-2: max. ±0.1%/year (of measuring range)

Installation

Panel mounting: mounting location and installation dimensions

The device is designed for use in a panel.

i The device must be installed in a pressurized enclosure system for operation in the hazardous area. To ensure safe installation, it is essential to follow the installation instructions for the cabinet and the installation instructions in the Ex-related Safety Instructions (XA).

Data sheet

Video recorder LINAX DR3000

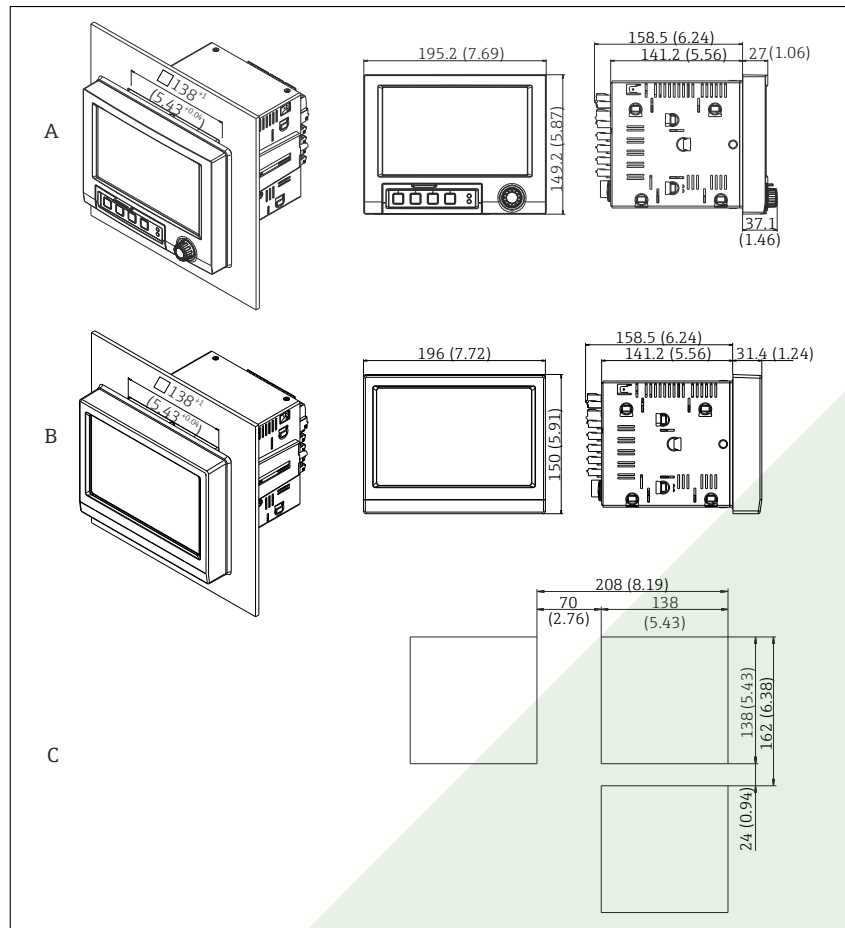

18 Panel mounting and dimensions in mm (in).

- A Version with navigator and front interfaces
- B Version with stainless steel front and touchscreen
- C Grid dimensions of panel cutouts for multiple devices

Installation dimensions

- Installation depth (excluding terminal cover): approx. 159 mm (6.26 in) for device incl. terminals and fastening clips.
- Installation depth including terminal cover (option): approx. 198 mm (7.8 in)
- Panel cutout: 138 to 139 mm (5.43 to 5.47 in) x 138 to 139 mm (5.43 to 5.47 in)
- Panel thickness: 2 to 40 mm (0.08 to 1.58 in)
- viewing angle range: 50° in all directions from the display central axis
- A minimum distance of 12 mm (0.47 in) between the devices must be observed if aligning the devices vertically above one another or horizontally beside one another.
- The grid dimension of the panel cutouts for multiple devices must be at least 208 mm (8.19 in) horizontally and at least 162 mm (6.38 in) vertically (tolerance not considered).
- Securing to DIN 43 834

Field housing assembly and design (optional)

As an option, the device can be ordered ready-mounted in a field housing with IP65. Dimensions (B x H x D) approx.: 320 mm (12.6 in) x 320 mm (12.6 in) x 254 mm (10 in)

Data sheet

Video recorder LINAX DR3000

Desktop housing assembly and design (optional) As an option, the device can be ordered ready-mounted in a desktop housing.
 Dimensions (B x H x D) approx.: 293 mm (11.5 in) x 188 mm (7.4 in) x 213 mm (8.39 in) (dimensions with bracket, feet and installed device)

Environment

Ambient temperature range	-10 to +50 °C (14 to 122 °F)	
Storage temperature	-20 to +60 °C (-4 to +140 °F)	
Humidity	5 to 85 %, not condensating	
Climate class	To IEC 60654-1: Class B2	
Electrical safety	Class I equipment, overvoltage category II Pollution level 2	
Altitude	< 2 000 m (6 561 ft) above MSL	
Degree of protection	Front	IP65 / NEMA 4 (not assessed by UL)
	Rear	IP20

Electromagnetic compatibility EMC to all relevant requirements of the IEC/EN 61326- series and NAMUR NE21. For details see declaration of conformity.

- Interference immunity: as per IEC/EN 61326 series (industrial environment) / NAMUR NE21
Maximum measured error <1% of measuring range
- Interference emissions: as per IEC 61326-1 Class A

Mechanical construction

Design, dimensions	Information about design and dimensions →  98	
Weight	<ul style="list-style-type: none"> ▪ Panel-mounted device with navigator and front interfaces (with maximum configuration): approx. 2.7 kg (5.9 lbs) ▪ Panel-mounted device with stainless steel front and touchscreen (with maximum configuration): approx. 3.2 kg (7 lbs) ▪ Desktop housing (excluding device): approx. 2.3 kg (5 lbs) ▪ Field housing (excluding device): approx. 4 kg (8.8 lbs) 	
Materials	Version with navigator and front interfaces	
	Front frame	Zinc die cast GD-Z410, powder-coated
	Display glass	Transparent Makrolon® plastic (FR clear 099) UL94-V2

Data sheet

Video recorder LINAX DR3000

Version with navigator and front interfaces	
Flap; jog/shuttle dial ("Navigator")	Plastic ABS UL94-V2
Membrane keypad	Polyester membrane PC-ABS UL94-V2
Intermediate frame (front towards control panel)	Plastic PA6-GF20 UL94-V2
Seal towards panel wall; seal in flap; seal towards navigator	Rubber EPDM 70 Shore A
Casing; rear panel	Galvanized sheet steel St 12 ZE

Version with stainless steel front and touchscreen	
Front frame	AISI 316L
Display glass	6 mm single-pane safety glass (soda-lime glass)
Intermediate frame (front towards control panel)	Plastic PA6-GF20 UL94-V2
Seal towards control panel wall	Rubber EPDM 70 Shore A
Window seal between front frame and glass	Rubber EPDM 60 Shore A
Casing; rear panel	Galvanized sheet steel St 12 ZE

Designation	Short form	Properties
AISI 316L (corresponds to 1.4404 or 1.4435)	X2CrNiMo17-13-2, X2CrNiMo18-14-3	Austenitic, stainless steel High corrosion resistance in general

 All materials are silicone-free.

Materials of desktop housing

- Housing half-panels: sheet steel, electrolytically plated (powder-coated)
- Side sections: aluminum extruded section (powder-coated)
- Section ends: colored polyamide
- Feet: colored polyamide, fiber-glass reinforced

Field housing materials

- Housing (front frame, door, base frame, side parts): thermoplastic polycarbonate PC
- Front panel and wall mounting: chrome-nickel stainless steel 1.4301 V2A

Display and operating elements

Operating concept

The device can be operated directly onsite, or via remote configuration with the PC via interfaces and operating tools (Web server).

Web server

A Web server is integrated into the device. The Web server offers the following range of functions:

- Easy configuration without additional installed software
- Instantaneous value display and diagnostics information
- Display of current measured value curves via Web browser (remote control)
- Loading/saving of device configuration
- Device firmware update
- Printout of device configuration

Data sheet

Video recorder LINAX DR3000

Integrated operating instructions

The device's simple control system enables you to perform commissioning for many applications without the need for hardcopy operating instructions. The device has an integrated help function and displays operating instructions directly on screen.

Local operation

Display elements

Type

Wide-screen TFT color graphic display (optionally with touch control)

Size (diagonal screen measurement)

178 mm (7")

Resolution

Wide VGA 384,000 pixels (800 x 480 pixels)

Backlight

50,000 h half value time (= half brightness)

Number of colors

262,000 viewable colors, 256 colors used

Viewing angle

Max. viewing angle range: 50° in all directions from the display central axis

Screen display

- Users can choose between black or white for the background color
- Active channels can be assigned to up to 10 groups. To clearly identify these groups, they can be assigned a name, such as "temp. boiler 1" or "daily averages".
- Scales linear or logarithmic
- Measured value history: quick retrieval of historic data with zoom function
- Preformatted display formats, such as horizontal or vertical curves, instrument display, circular chart, process screen, bargraph or digital display.

Data sheet

Video recorder LINAX DR3000

Measured value display and operating elements

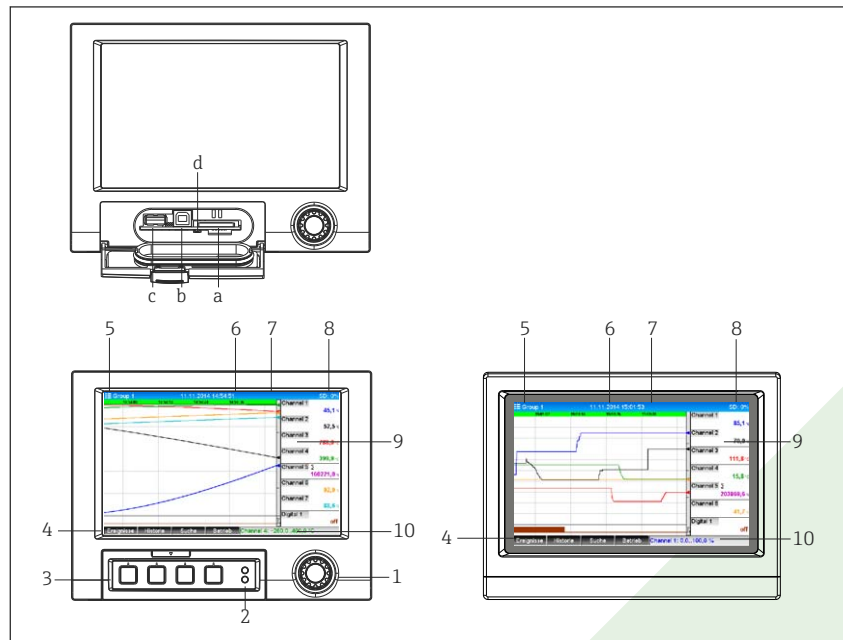

19 Device front (left: version with navigator and front interfaces; right: version with stainless steel front and touchscreen)

Item No.	Operating function (display mode = display of measured values) (Setup mode = operating in the Setup menu)
a	Slot for SD card
b	USB B socket "Function" e.g. to connect to PC or laptop
c	USB A socket "Host" e.g. for USB memory stick, external keyboard, barcode reader or printer
d	LED at SD slot. Yellow LED lit or flashing when the device writes to the SD card or reads it. Do not remove the SD card if the LED is lit or flashing! Risk of data loss!
1	"Navigator": jog/shuttle dial for operating with additional press/hold function. In display mode: turn the dial to switch between the various signal groups. Press the dial to display the main menu. In setup mode or in a selection menu: turn the dial anticlockwise to move the bar or the cursor upwards or counterclockwise, changes the parameter. Turning clockwise moves the bar or cursor down or clockwise, changes parameter. Press = select highlighted function, start parameter change (ENTER key).
2	Functions of LED indicators (according to NAMUR NE44:): <ul style="list-style-type: none"> ■ Green LED (top) lit: power supply OK ■ Red LED (bottom) flashing: maintenance required, caused by external factor (e.g. cable open circuit etc.), or a message/notification requiring acknowledgment is pending, calibration is running.
3	Variable "soft keys", keys 1 to 4 (from left to right)
4	Function indicator of the "soft keys"
5	In display mode: current group name, type of analysis; In setup mode: name of the current operating item (dialog title)
6	In display mode: displays current date/time In setup mode: --
7	In display mode: user ID (if function is active) In setup mode: --

Data sheet

Video recorder LINAX DR3000

Item No.	Operating function (display mode = display of measured values) (Setup mode = operating in the Setup menu)
8	In display mode: alternating display indicating the percentage space on the SD card or USB stick that has already been used. Status symbols are also displayed in alternation with the memory information (e.g. simulation mode, data storage active, operation locked, batch active) In setup mode: the current "direct access" operating code is displayed
9	In display mode: window for measured value display (e.g. curve display). Display of current measured values and the status in the event of an error/alarm condition. In the case of counters, the type of counter is displayed as a symbol.  If a measuring point has limit value status, the corresponding channel identifier is highlighted in red (quick detection of limit value violations). During a limit value violation and device operation, the acquisition of measured values continues uninterrupted.
9	In setup mode: display of operating menu
10	In display mode: alternating status display (e.g. set zoom range) of the analog or digital inputs in the appropriate color of the channel. In setup mode: different information is displayed here depending on the display type.

Languages

The following languages can be selected in the operating menu: German, English, Spanish, French, Italian, Dutch, Swedish, Polish, Portuguese, Czech, Russian, Japanese, Chinese (Traditional), Chinese (Simplified)

Remote operation

Device access via operating tools

Device configuration and measured value retrieval can also be done via interfaces. The following operating tools are available for this purpose:

Operating tool	Functions	Access via
Analysis software, SQL database support (included in the delivery)	<ul style="list-style-type: none"> ▪ Export of saved data (measured values, analyses, event log) ▪ Visualization and processing of saved data (measured values, analyses, event log) ▪ Safe archiving of exported data in a SQL database 	RS232/RS485, USB, Ethernet
Web server (integrated into the device; access via browser)	<ul style="list-style-type: none"> ▪ Display of current and historical data and measured value curves via the web browser ▪ Easy configuration without additional installed software ▪ Remote access to device and diagnostic information 	Ethernet
OPC server (optional)	The following momentary values can be provided: <ul style="list-style-type: none"> ▪ Analog channels ▪ Digital channels ▪ Mathematics ▪ Totalizer 	RS232/RS485, USB, Ethernet

Certificates and approvals

CE mark

The measuring system meets the legal requirements of the applicable EC guidelines. These are listed in the corresponding EC Declaration of Conformity together with the standards applied. Confirms successful testing of the device by affixing to it the CE mark.

Electronic recording/ electronic signature

FDA 21 CFR Part 11

The device meets the requirements of the "Food and Drug Administration" for electronic recording/electronic signature.

Datenblatt

Bildschirmschreiber LINAX DR3000

Certifications	<ul style="list-style-type: none">▪ HART® certification (HCF)▪ PROFINET certification▪ EtherNet/IP certification
Other standards and guidelines	<ul style="list-style-type: none">▪ IEC 60529: Degree of protection provided by housing (IP code)▪ IEC/EN 61010-1: Safety requirements for electrical equipment for measurement, control and laboratory use▪ IEC/EN 61326 Series: Electromagnetic compatibility (EMC requirements)

Ordering information



The hazardous area version (Ex version) is only available in conjunction with the stainless steel front and touch control.

Scope of delivery	<p>The scope of delivery of the device comprises:</p> <ul style="list-style-type: none">▪ Device (with terminals, as per order)▪ 2 fastening clips▪ Version with navigator and front interfaces: USB cable▪ Sealing rubber towards control panel wall▪ Optional: "Industrial Grade" SD card, industry standard: Version with navigator and front interfaces: card is located in the SD slot behind the flap on the front of the housing (optional). Version with stainless steel front and touchscreen: card is in the device and cannot be replaced or retrofitted.▪ Analysis software on CD-ROM▪ Operating Instructions on CD-ROM
-------------------	---



CAMILLE BAUER

Auf uns ist Verlass.

Camille Bauer Metrawatt AG
Aargauerstrasse 7
CH-5610 Wohlen / Switzerland
Phone: +41 56 618 21 11
Fax: +41 56 618 21 21
info@cbmag.com
www.camillebauer.com